

GATEMASTER SBQEKL Bolt On Cylinder Exit Pushpad

Gate Locks · Gatemaster · 4 variants

PRICING

From £224.29 ex VAT

£269.15 inc VAT

4 variants available
VAT 20.00%

Product Imagery

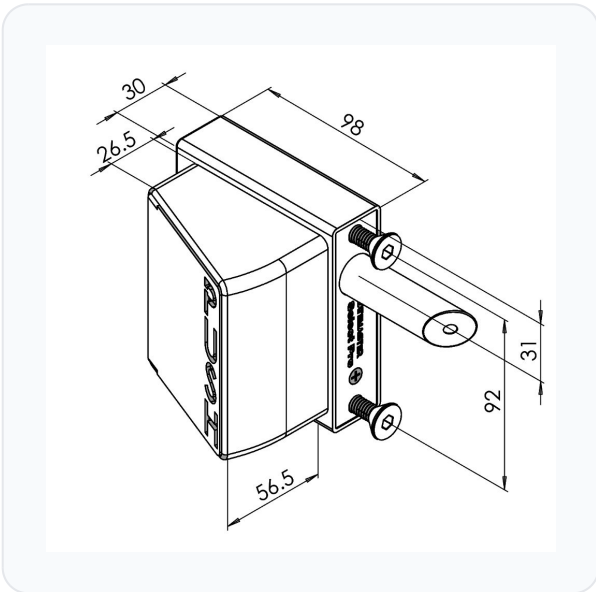

L.H. Lock

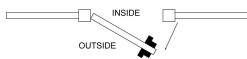

R.H. Lock

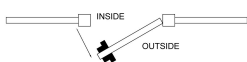

Specification Summary

Brand	Gatemaster
Product type	Gate Locks

Product Description

The Gatemaster SBQEKL Bolt On Cylinder Exit Pushpad is a robust, marine-grade gate lock designed to provide quick and secure egress for metal gates. Combining a green pushpad on the inside for rapid exit with a key-operated cylinder on the outside, it is ideal for communal areas, schools, and commercial premises where emergency or quick exit is required.

Built for durability, this lock features a marine-grade construction that is highly weather-resistant. It is designed to be bolted directly onto the gate frame, making installation straightforward without the need for welding. The 16mm

stainless steel latchbolt is adjustable in length and springs 22mm into the gate post, ensuring a secure and smooth locking action.

This gate lock is available in multiple configurations to suit your specific installation requirements. It comes in both **Left Hand** and **Right Hand** versions, and is designed to fit gate frames measuring either **10mm to 30mm** or **40mm to 60mm** in thickness. Please select your required handing, gate frame size, and corresponding latchbolt length from the options below to ensure the perfect fit for your gate.

Technical Specifications

- **Brand:** Gatemaster
- **Finish:** Black & Green
- **Latchbolt:** 16mm stainless steel latchbolt (springs 22mm into the gate post)
- **Gate Frame Size:** To suit 10mm to 30mm or 40mm to 60mm frames (please choose from the options below)
- **Handing:** Left Hand or Right Hand (please choose from the options below)
- **Latchbolt Length:** 35mm (15mm in closed position) or 70mm (48mm in closed position) depending on variant
- **Width:** 98mm
- **Weight:** 1.687kg

Key Features

- **Quick Exit Pushpad:** Green pushpad on the inside allows for rapid and easy egress.
- **Secure Key Entry:** Key-operated cylinder on the outside provides secure access control.
- **Marine Grade & Weather Resistant:** Designed to withstand harsh outdoor environments.
- **Easy Bolt-On Installation:** Simple to install with the supplied fixing bolts, requiring no welding.
- **Adjustable Latchbolt:** 16mm stainless steel latchbolt can be adjusted in length for a precise fit.
- **Complete Kit:** Supplied with a bolt support plate, gate post strike plate, and 3 keys.

Variant Specifications And Pricing



Image	Part Number	Ex VAT	Inc VAT	Attributes / Specs
	L26934	£224.29	£269.15	<p>Barcode: 5055120782492</p> <p>Brand: Gatemaster</p> <p>Door Thickness: To suit 10mm to 30mm gate frames</p> <p>Finish: Black & Green</p> <p>Handed: Left Hand</p> <p>Latch: 16mm Latchbolt</p> <p>Manufacturer Reference: SBQEKLL01</p> <p>Notes: Latchbolt Length: 35mm (15mm in closed position)</p> <p>Pack Quantity: 1</p> <p>Weight: 1.687Kg</p> <p>Width: 98mm</p>
	L26935	£224.29	£269.15	<p>Barcode: 5060910281291</p> <p>Brand: Gatemaster</p> <p>Door Thickness: To suit 10mm to 30mm gate frames</p> <p>Finish: Black & Green</p> <p>Handed: Right Hand</p> <p>Latch: 16mm Latchbolt</p> <p>Manufacturer Reference: SBQEKLR01</p> <p>Notes: Latchbolt Length: 35mm (15mm in closed position)</p> <p>Pack Quantity: 1</p> <p>Weight: 1.687Kg</p> <p>Width: 98mm</p>
	L26936	£224.29	£269.15	<p>Barcode: 5055120782515</p> <p>Brand: Gatemaster</p> <p>Door Thickness: To suit 40mm to 60mm gate frames</p> <p>Finish: Black & Green</p> <p>Handed: Left Hand</p> <p>Latch: 16mm Latchbolt</p> <p>Manufacturer Reference: SBQEKLL02</p> <p>Notes: Latchbolt Length: 70mm (48mm in closed position)</p> <p>Pack Quantity: 1</p> <p>Weight: 1.687Kg</p> <p>Width: 98mm</p>

Image	Part Number	Ex VAT	Inc VAT	Attributes / Specs
	L26937	£224.29	£269.15	<p>Barcode: 5060910281307</p> <p>Brand: Gatemaster</p> <p>Door Thickness: To suit 40mm to 60mm gate frames</p> <p>Finish: Black & Green</p> <p>Handed: Right Hand</p> <p>Latch: 16mm Latchbolt</p> <p>Manufacturer Reference: SBQEKLRO2</p> <p>Notes: Latchbolt Length: 70mm (48mm in closed position)</p> <p>Pack Quantity: 1</p> <p>Weight: 1.687Kg</p> <p>Width: 98mm</p>

Brand Profile

Gatemaster

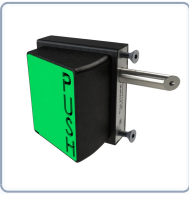

Gatemaster is a UK manufacturer specialising in **gate locks and gate hardware** for **metal and wooden gates**, with a reputation built on one simple promise: **make it strong, make it weatherproof, and make it easy to fit** (because installers have better things to do than spend their afternoon arguing with a latch).

The company's story starts in **1995**, when founder **Simon** began making locks under the name **Signet Locks**, initially producing from his **garage in South London** before growing into a proper workshop and eventually scaling into a dedicated manufacturing operation. As the business expanded, the **manufacturing side became Gatemaster**, while **Signet** continued as the UK trading name in the same ecosystem.

Gatemaster's best-known product family is the **Superlock** series—bolt-on gate locks offered in variants like **key + handle, mechanical keypad (code) access**, and even **panic-exit** options—designed for heavy outdoor use and installer-friendly fitting. The company leans hard into “bolt-on simplicity”: many of their locks are marketed as installable by drilling a small number of holes and fastening the unit to the gate frame.

Operationally, Gatemaster is based in **Bognor Regis, West Sussex** (with warehousing/distribution also referenced there), and the UK company record for **GATEMASTER LTD** lists its registered office at **Unit 5 Dickinson Place, Durban Road Industrial Estate, Bognor Regis, PO22 9QU**.