

EVVA AirKey Euro Double Proximity - Key ICS Cylinder

Euro Proximity & Key Cylinder · Evva · 6 variants

PRICING

From £659.85 ex VAT

£791.82 inc VAT

6 variants available

VAT 20.00%

Range: £659.85 - £838.64 ex VAT

Product Imagery

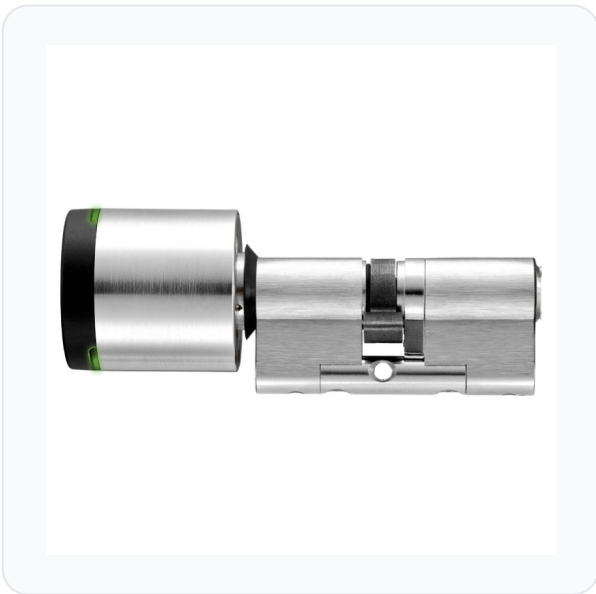

Specification Summary

Brand	Evva
Product type	Euro Proximity & Key Cylinder

Product Description

The EVVA AirKey Euro Double Proximity - Key ICS Cylinder is an innovative hybrid locking solution that combines advanced electronic access control with high-security mechanical protection. Designed to replace a standard Euro cylinder, this system features a smart proximity reader knob on one side and a robust EVVA ICS (Internal Code System) mechanical key cylinder on the other.

The electronic side allows users to unlock doors using compatible smartphones or proximity media, with an audit trail that logs the last 1,000 events. It is powered by two CR2 batteries, providing up to 30,000 operations, and features an IP65 weather-resistant rating, making it suitable for external doors. The mechanical side utilizes the highly secure, patent-protected ICS key system, supplied keyed to differ with zero keys included.

This versatile cylinder is available in multiple finishes, including Nickel Plated, Patina Brown (Bronze), and Polished Brass, and in overall lengths ranging from 62mm to 122mm. Please select your preferred finish, length, and specification from the options below.

Technical Specifications

- **Brand:** EVVA
- **Cylinder Profile:** Euro
- **Cylinder Type:** Double Euro (Proximity / Key)
- **Cylinder System:** EVVA AirKey / ICS
- **Mechanism:** Proximity (Electronic) / Key (Mechanical)
- **Keying:** Keyed to differ (0 keys supplied)
- **Battery:** 2 x CR2 (included)
- **Battery Life:** Up to 30,000 operations
- **IP Rating:** IP65
- **Operating Temperature:** -20°C to 55°C
- **Audit Trail:** Last 1,000 events
- **Knob Diameter:** 39mm
- **Knob Projection:** 45mm
- **Handing:** Reversible
- **Standards:** BS EN 1634-1, CE Marked, Certifire

Key Features

- **Hybrid Security:** Combines smart electronic proximity access on one side with a high-security mechanical ICS key cylinder on the other.
- **Smart Access Control:** Manage access permissions online and open doors using compatible smartphones or NFC/RFID proximity media.
- **Weatherproof Protection:** IP65-rated electronic knob is suitable for external doors and harsh weather conditions.
- **Audit Trail Tracking:** Logs the last 1,000 events for enhanced security monitoring and access oversight.
- **Long Battery Life:** Powered by two CR2 batteries, offering up to 30,000 operations with visual status indication.
- **Multiple Options:** Available in a range of lengths and finishes - please select your required options below.

Variant Specifications And Pricing

Image	Part Number	Ex VAT	Inc VAT	Attributes / Specs
	L31660	£659.85	£791.82	<p>Audit Trail: Last 1,000 events Barcode: 5056240120454 Battery: 2 x CR2 Battery Life: 30,000 Operations Brand: Evva Cylinder Kitemark: No Cylinder Profile: Euro Cylinder System: Evva AirKey Cylinder Type: Double Euro Finish: Nickel Plated Fire Tested: Grade 0 Handed: Reversible Humidity: Humidity < 90 %, non-condensing IP Rating: IP65 Key Override: No Keyed: Keyed To Differ Keys Supplied: 0 Knob Diameter: 39mm Knob Projection: 45mm Length: 0mm Manufacturer Reference: E.ICS.PZ.DZ-S.NI Mechanism: Proximity Notes: 62mm to 92mm Operating Temperature: -20°C to 55°C Pack Quantity: 1 Secured By Design: No Snap Resistant: No Sold Secure: No Standards: BS EN 1634-1, CE Marked, Certifire Visual Indication: Yes Weight: 356g</p>

Image	Part Number	Ex VAT	Inc VAT	Attributes / Specs
	L31661	£700.44	£840.53	<p> Audit Trail: Last 1,000 events Barcode: 5056240120461 Battery: 2 x CR2 Battery Life: 30,000 Operations Brand: Evva Cylinder Kitemark: No Cylinder Profile: Euro Cylinder System: Evva AirKey Cylinder Type: Double Euro Finish: Nickel Plated Fire Tested: Grade 0 Handed: Reversible Humidity: Humidity < 90 %, non-condensing IP Rating: IP65 Key Override: No Keyed: Keyed To Differ Keys Supplied: 0 Knob Diameter: 39mm Knob Projection: 45mm Length: 0mm Manufacturer Reference: E.ICS.PZ.DZ-S.NI Mechanism: Proximity Notes: 97mm to 122mm Operating Temperature: -20°C to 55°C Pack Quantity: 1 Secured By Design: No Snap Resistant: No Sold Secure: No Standards: BS EN 1634-1, CE Marked, Certifire Visual Indication: Yes Weight: 356g </p>

Image	Part Number	Ex VAT	Inc VAT	Attributes / Specs
	L31662	£740.78	£888.94	<p> Audit Trail: Last 1,000 events Barcode: 5056240120478 Battery: 2 x CR2 Battery Life: 30,000 Operations Brand: Evva Cylinder Kitemark: No Cylinder Profile: Euro Cylinder System: Evva AirKey Cylinder Type: Double Euro Finish: Polished Brass Fire Tested: Grade 0 Handed: Reversible Humidity: Humidity < 90 %, non-condensing IP Rating: IP65 Key Override: No Keyed: Keyed To Differ Keys Supplied: 0 Knob Diameter: 39mm Knob Projection: 45mm Length: 0mm Manufacturer Reference: E.ICS.PZ.DZ-S.MP Mechanism: Proximity Notes: 62mm to 92mm Operating Temperature: -20°C to 55°C Pack Quantity: 1 Secured By Design: No Snap Resistant: No Sold Secure: No Standards: BS EN 1634-1, CE Marked, Certifire Visual Indication: Yes Weight: 356g </p>

Image	Part Number	Ex VAT	Inc VAT	Attributes / Specs
	L31663	£781.37	£937.64	<p> Audit Trail: Last 1,000 events Barcode: 5056240120485 Battery: 2 x CR2 Battery Life: 30,000 Operations Brand: Evva Cylinder Kitemark: No Cylinder Profile: Euro Cylinder System: Evva AirKey Cylinder Type: Double Euro Finish: Polished Brass Fire Tested: Grade 0 Handed: Reversible Humidity: Humidity < 90 %, non-condensing IP Rating: IP65 Key Override: No Keyed: Keyed To Differ Keys Supplied: 0 Knob Diameter: 39mm Knob Projection: 45mm Length: 0mm Manufacturer Reference: E.ICS.PZ.DZ-S.MP Mechanism: Proximity Notes: 97mm to 122mm Operating Temperature: -20°C to 55°C Pack Quantity: 1 Secured By Design: No Snap Resistant: No Sold Secure: No Standards: BS EN 1634-1, CE Marked, Certifire Visual Indication: Yes Weight: 356g </p>

Image	Part Number	Ex VAT	Inc VAT	Attributes / Specs
	L31664	£798.05	£957.66	<p> Audit Trail: Last 1,000 events Barcode: 5056240120492 Battery: 2 x CR2 Battery Life: 30,000 Operations Brand: Evva Cylinder Kitemark: No Cylinder Profile: Euro Cylinder System: Evva AirKey Cylinder Type: Double Euro Finish: Patina Brown (Bronze) Fire Tested: Grade 0 Handed: Reversible Humidity: Humidity < 90 %, non-condensing IP Rating: IP65 Key Override: No Keyed: Keyed To Differ Keys Supplied: 0 Knob Diameter: 39mm Knob Projection: 45mm Length: 0mm Manufacturer Reference: E.ICS.PZ.DZ-S.PB Mechanism: Proximity Notes: 62mm to 92mm Operating Temperature: -20°C to 55°C Pack Quantity: 1 Secured By Design: No Snap Resistant: No Sold Secure: No Standards: BS EN 1634-1, CE Marked, Certifire Visual Indication: Yes Weight: 356g </p>

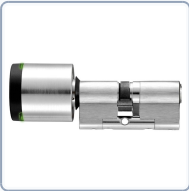
Image	Part Number	Ex VAT	Inc VAT	Attributes / Specs
	L31665	£838.64	£1006.37	<p> Audit Trail: Last 1,000 events Barcode: 5056240120508 Battery: 2 x CR2 Battery Life: 30,000 Operations Brand: Evva Cylinder Kitemark: No Cylinder Profile: Euro Cylinder System: Evva AirKey Cylinder Type: Double Euro Finish: Patina Brown (Bronze) Fire Tested: Grade 0 Handed: Reversible Humidity: Humidity < 90 %, non-condensing IP Rating: IP65 Key Override: No Keyed: Keyed To Differ Keys Supplied: 0 Knob Diameter: 39mm Knob Projection: 45mm Length: 0mm Manufacturer Reference: E.ICS.PZ.DZ-S.PB Mechanism: Proximity Notes: 97mm to 122mm Operating Temperature: -20°C to 55°C Pack Quantity: 1 Secured By Design: No Snap Resistant: No Sold Secure: No Standards: BS EN 1634-1, CE Marked, Certifire Visual Indication: Yes Weight: 356g </p>

Brand Profile

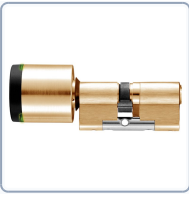
Evva

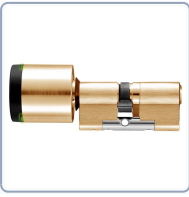

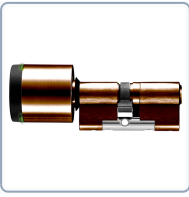
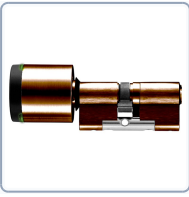
EVVA is an Austrian, **family-owned** security manufacturer based in **Vienna**, specialising in high-end **mechanical and electronic locking systems** for everything from homes to large, complex master-keyed organisations. The company was **founded in Vienna in 1919**, and it still runs **research, development, and production** from its Vienna headquarters, exporting globally.

In the trade/spec world, EVVA's reputation is built on **serious key control** and **master key system engineering**—locks designed not just to resist attack, but to keep access hierarchies manageable at scale (offices, hospitals, residential complexes, universities, etc.).

A couple of EVVA's standout mechanical platforms get referenced constantly:

- **ICS (Inner Code System)** – a reversible key system aimed at **highly complex master key structures**, with EVVA citing long patent protection (into the 2030s, depending on jurisdiction).
- **MCS (Magnetic Code System)** – EVVA positions this as a top-tier system for sophisticated master keying, with a strong anti-copying story (including resistance to modern replication methods).

They also explicitly brand themselves around innovation: EVVA talks about holding **200+ patents** and frames its history as “start-up energy since 1919” (which is an absolutely deranged sentence for a century-old lock company, but I respect the audacity).